

Subject – English

Summer vacation Assignment of English reader

Q1. Draw and colour Birthday Cake and Write your Name ?



Q2. Write about 'Myself' in five lines .

Ans.

1. My name is _____.
2. I am _____ years old.
3. I study in class _____.
4. The name of my school is _____.
5. I live in _____.

Q3 .Paste the picture of Zoo with different kind of animals.

Ans.

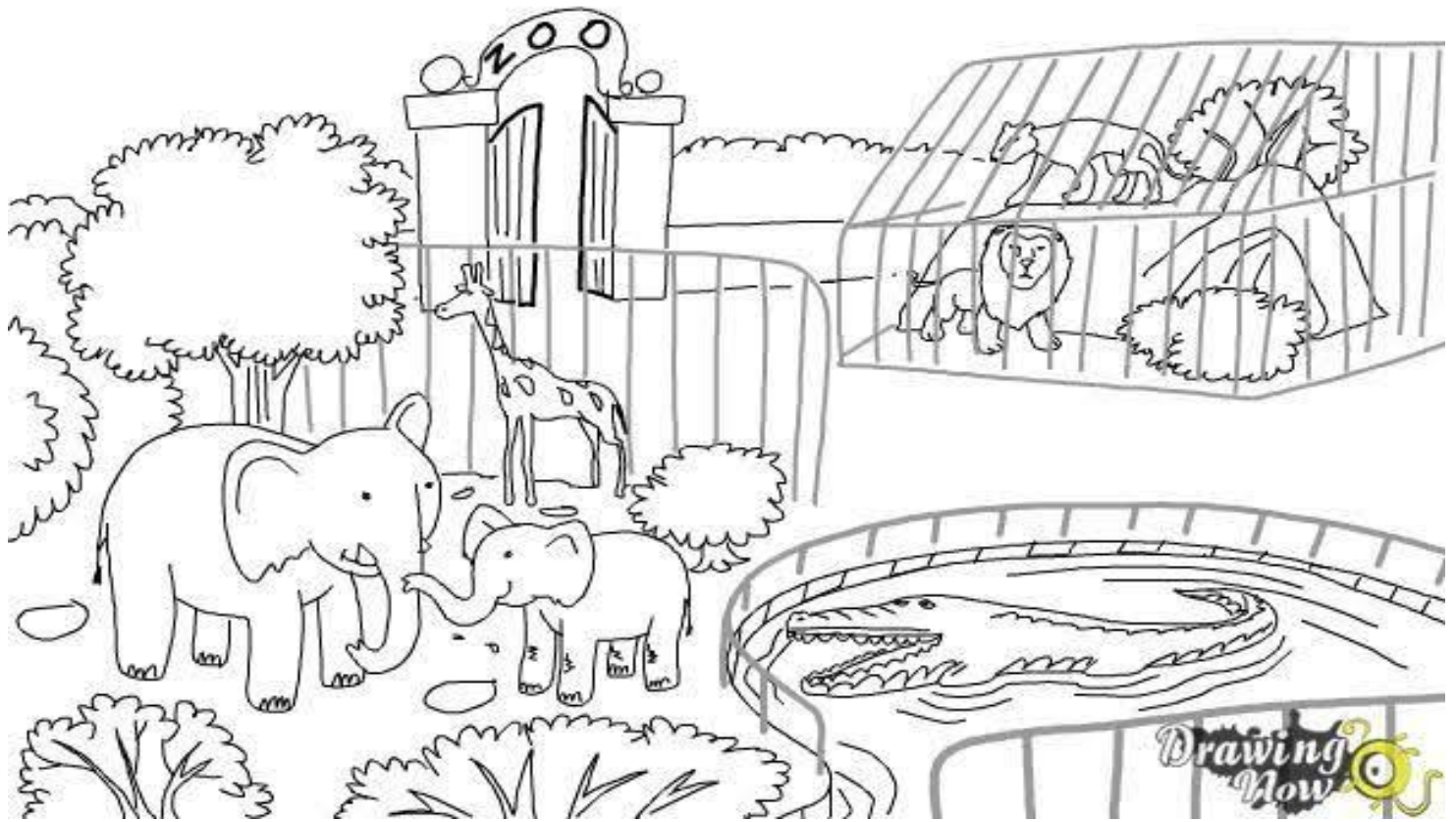

Drawing Now 

मिला कर लिखें और पढ़ें :

Subject – Hindi

Summer vacation Assignment of

हिंदी वर्कशीट

अ. दो अक्षर वाले शब्द :-



घ

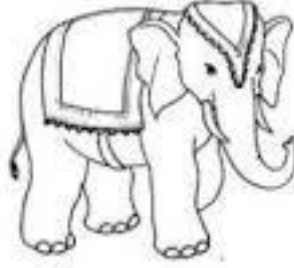

ग



फ



ई

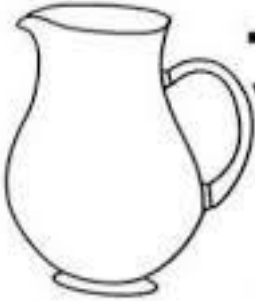

ज



प

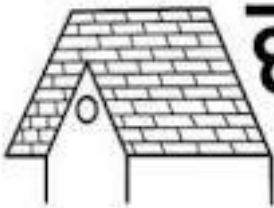

छ



ब



ध

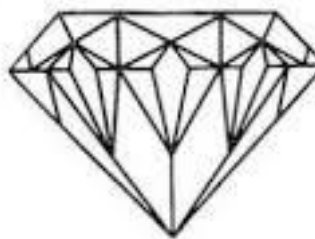

न

मिला कर लिखें और पढ़ें :

चित्रों के नाम की शुरुआत की आवाज वर्ण इस थैली में है ढूँढ कर लिखो

ढूँढकर लिखो-



 अचार	 म	 मली	
 द	 ठना	 न	
 क	 नक	 ठ	 ज़ार

सही स्वर लिखकर माला पूरी करो



मिला कर लिखें और पढ़ें :

चिन्हा देखकर शब्दों से मिलाये :

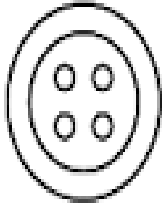

पतंग

बटन

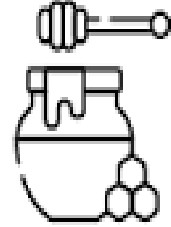

बतख

मटर

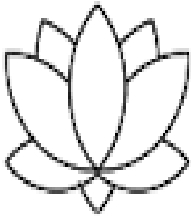

कमल

रबड़

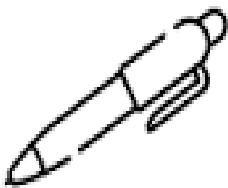
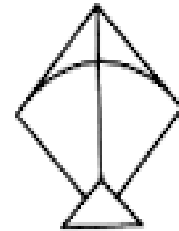

शहद

भगत



मगर

कलम

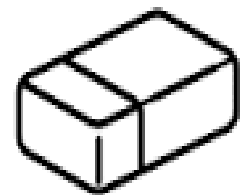

मिला कर लिखें और पढ़ें :

मिला कर लिखें और पढ़ें :

कट	हल	→	कटहल
बच	पन	→	
बर	तन	→	
अच	कन	→	
उब	टन	→	
कर	धन	→	
मज	हब	→	
कर	तब	→	

मिला कर लिखें और पढ़ें :

आ की मात्रा वाले शब्द:



अ + ा + म

=



न + ा + क

=

4

च + ा + र

=



क + ा + र

=



घ + ा + स

=

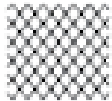

ज + ा + ल

=



ग + म + ल + ा

=



छ + ा + त + ा

=

Subject – Maths Summer vacation Assignment of Maths

Circle the bigger one:

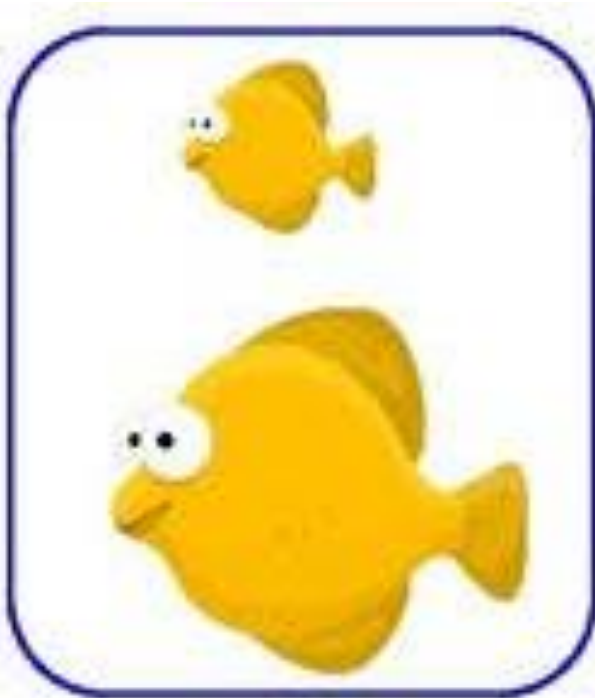

Missing number 1-50:



			16		30		44
				24		38	
1	6		18		32		
		12					47
	8			27			
4		14	21			42	
	10				36		

Colour the short toothpaste

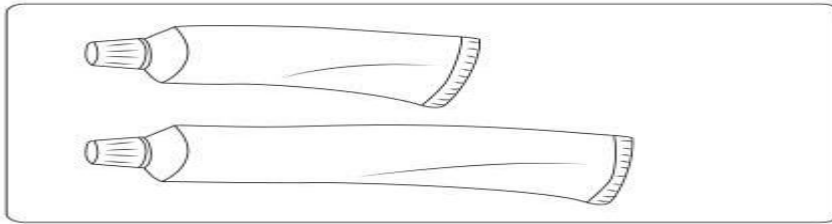

Colour the long toothpaste

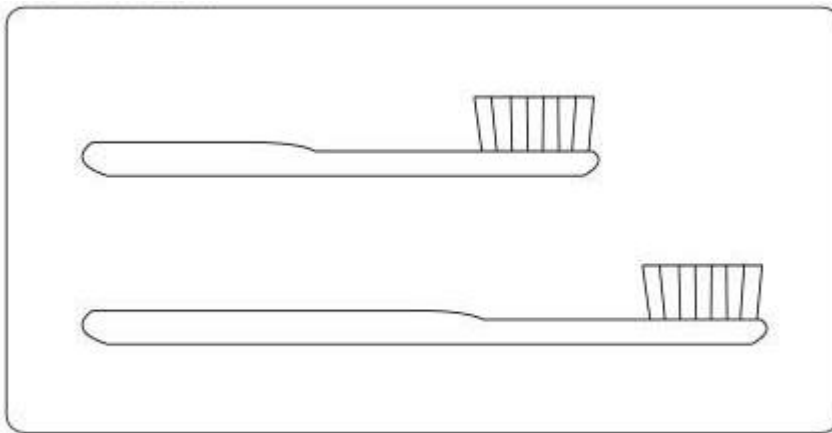

Draw a cross on the fat kid and draw an apple to thin kids hand

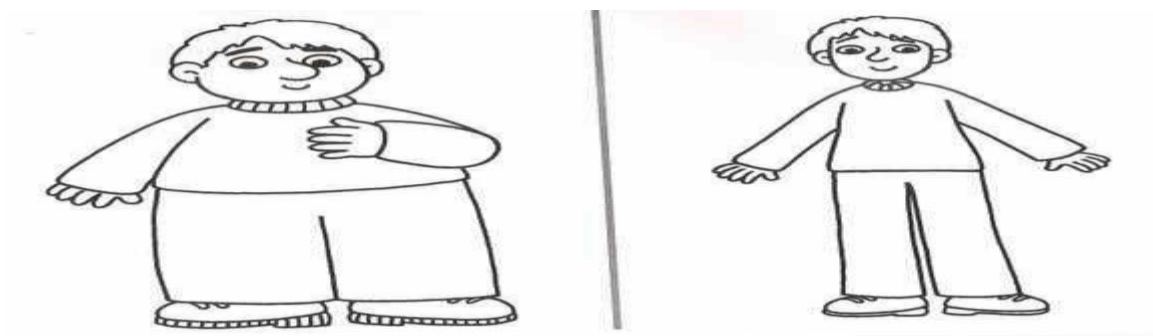

Colour the shorter one in each box:

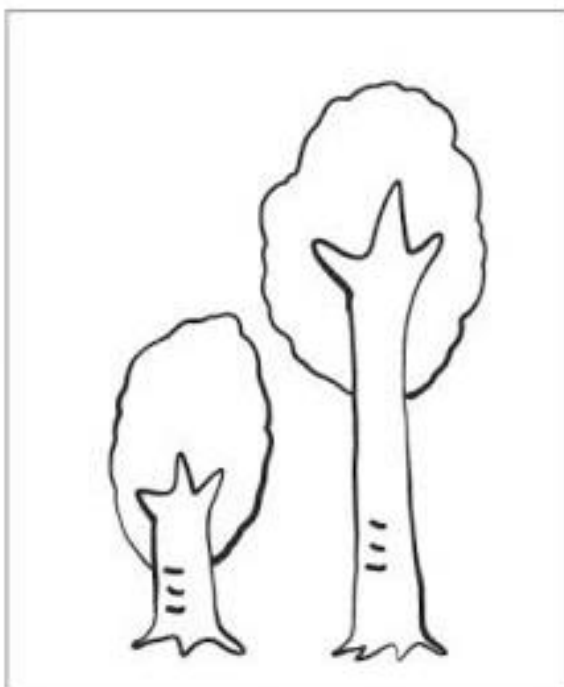
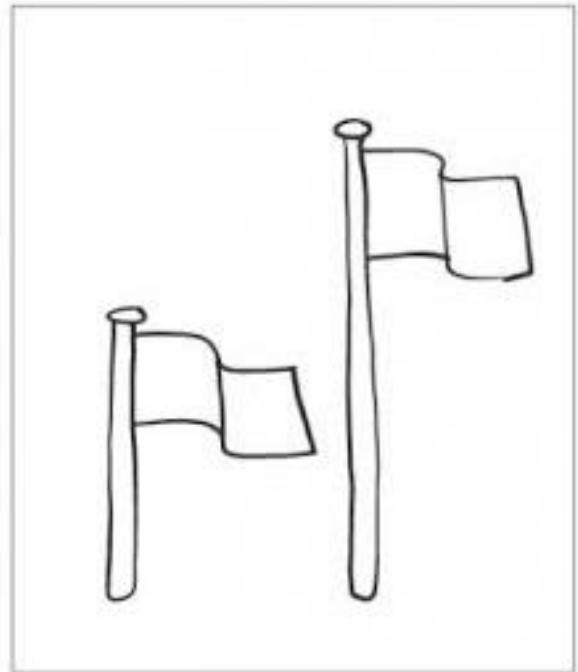
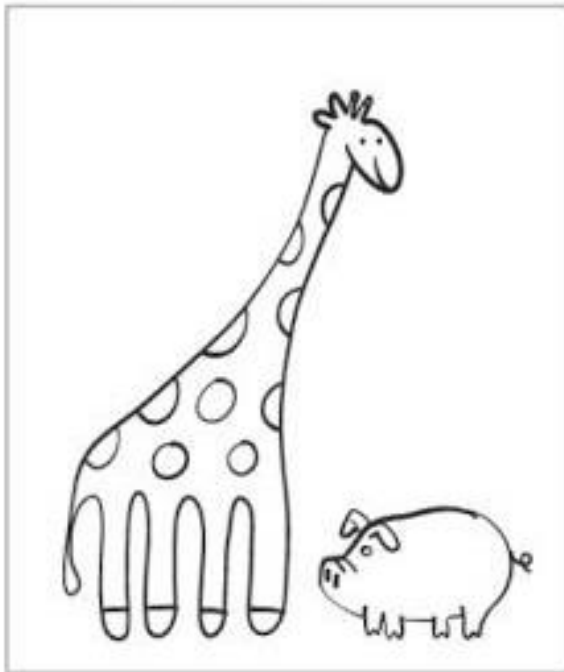

Summer vacation _____ Assignment of EVS

Q1. Draw and colour the five sense organs and write their names .

Ans.

1.Eyes –



2. Nose –



3. Ears –



4. Tongue -



5. Skin –



Fill in the blanks with picture clue :



1. I see with my _____.
2. I touch and feel with my _____.
3. I hear with my _____.
4. I smell with my _____.
5. I taste with my _____.